

1. Lap clip

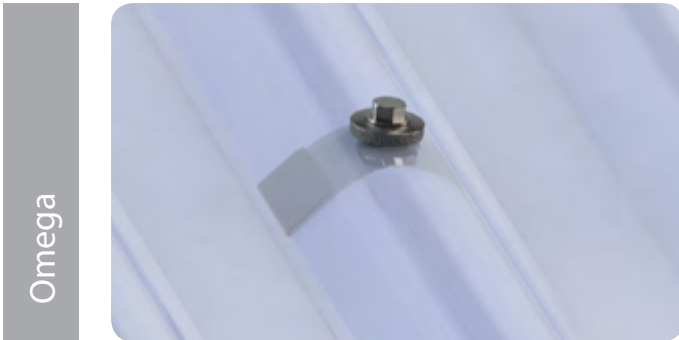

Omega

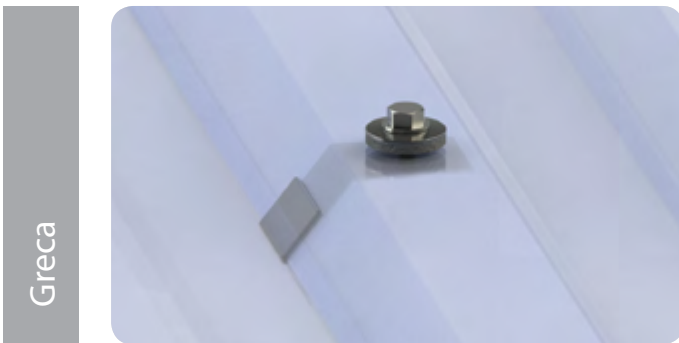

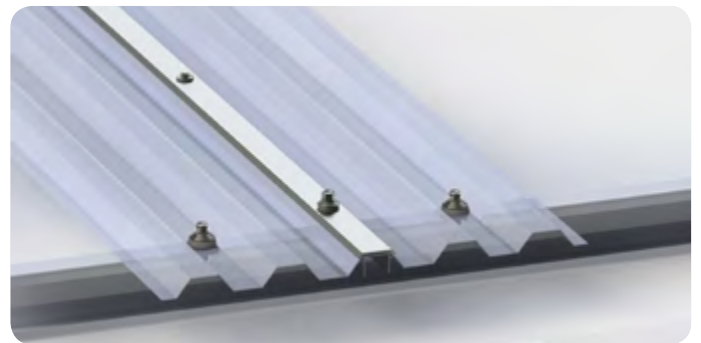
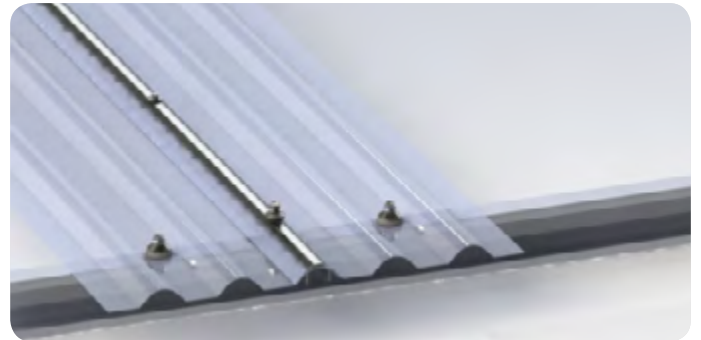

Greca

2. Side Lap Profile

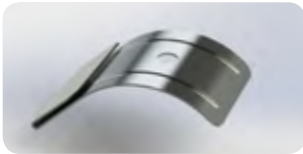
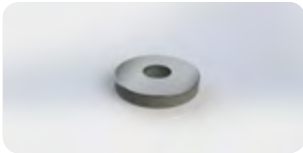

1. Lap Clip (Patent pending) Components

Component	Drawing	Component	Drawing
Lap clip - Omega		Lap clip - Greca	
5/8" washer/ Gasket		3/4" x 10 self tapping screw Fixed with lap clip at corrugation overlaps.	
19mm Gasket / Washer		1/4" x 2 Self drilling screw Fixed on corrugation crest above purlins.	

Lap clip Installation Guidelines

Side elevation omega



Side elevation greca

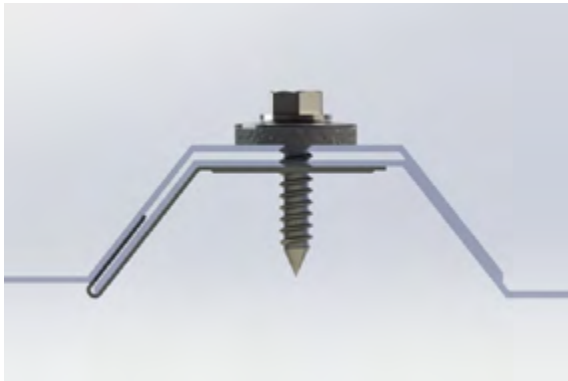

2

Place the lap clips between purlins at gaps of 300mm-400mm from one another.

1

Install the first SUNTUF Plus sheet according to PALRAM's installation instructions.

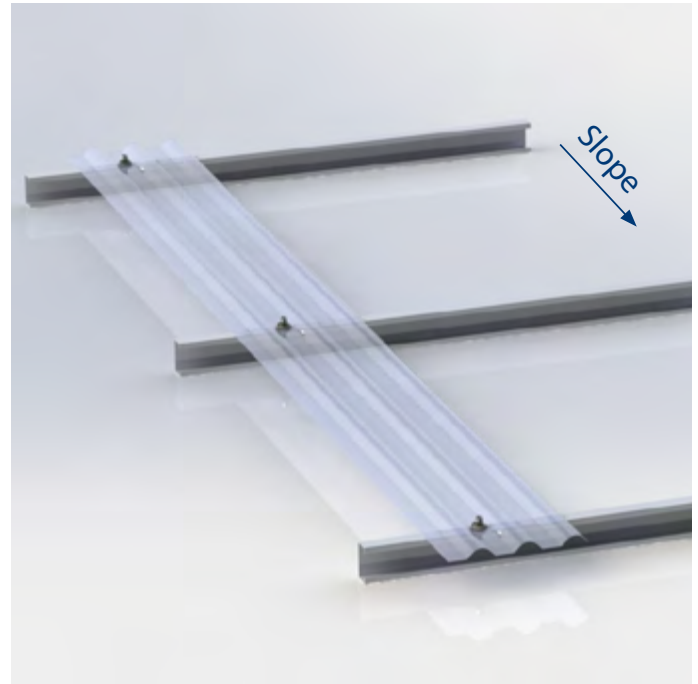



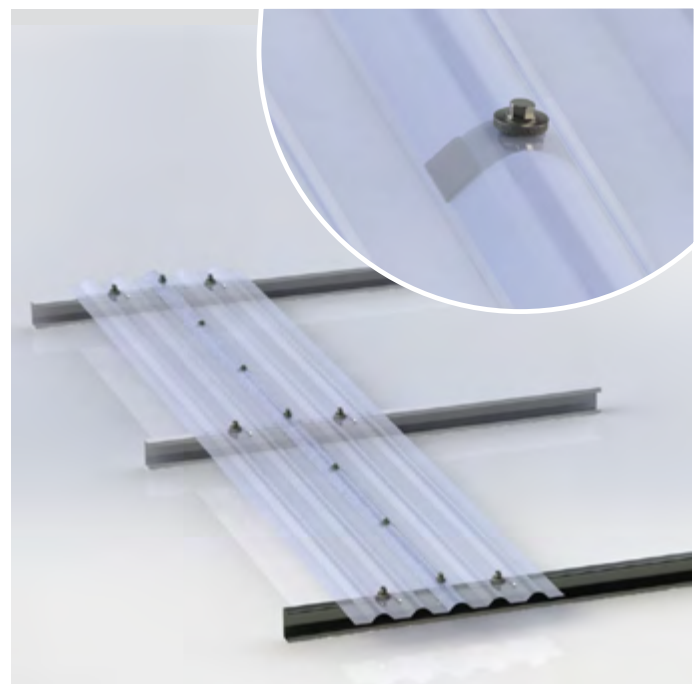
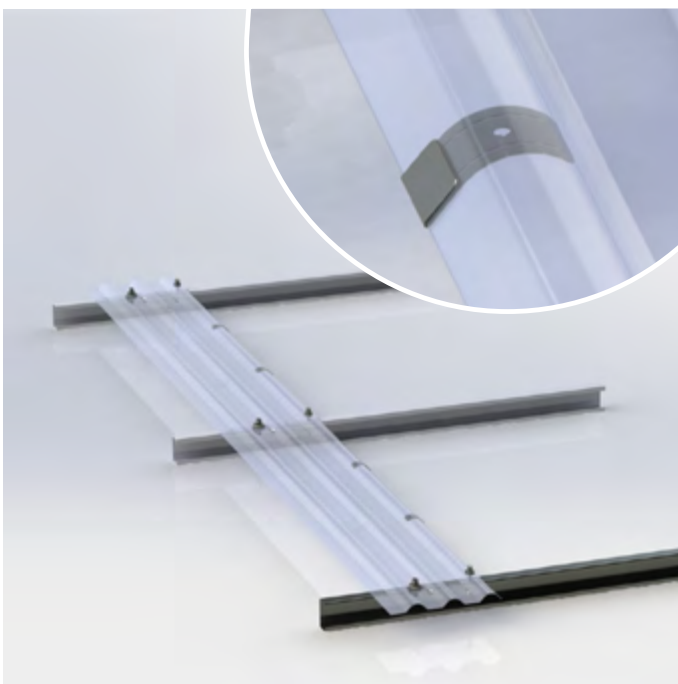

3

Place top sheet with corrugation over the lap-clip. Insert 3/4*10 screw with 5/8 washer/gasket through the sheet and the lap-clip bore. Use 1/4*2 self drilling screw with 19mm washer/gasket above purlins.

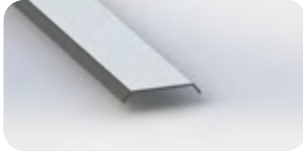
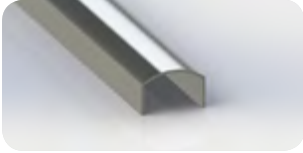
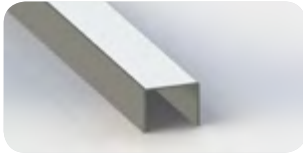

2. Side lap profile

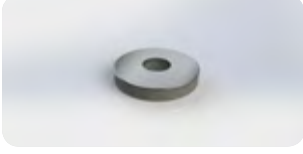
Components

Component	Drawing	Component	Drawing
Side lap profile top part - Omega		Side lap profile top part - Greca	
Side lap bottom part - Omega		Side lap profile bottom part - Greca	
5/8" washer/ Gasket		3/4"*10 self tapping screw Fixed with lap clip at corrugation overlaps.	
19mm Gasket / Washer		1/4"*2 Self drilling screw Fixed on corrugation crest above purlins.	

Side lap profile Installation Guidelines

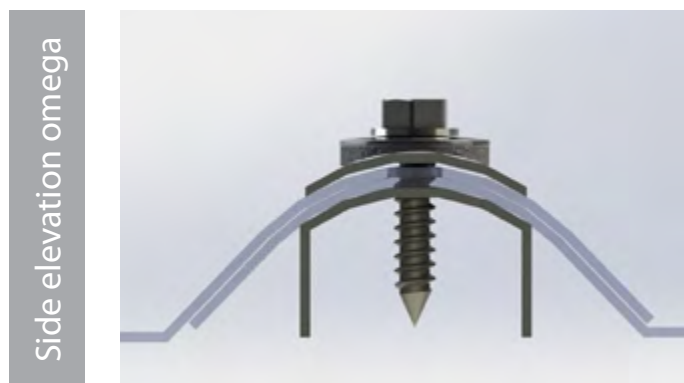

Preparing for installation

Fix top and bottom parts of side lap profile to match one another using adjustable pliers.
Using 5.5mm drill, prepare bores through the side lap profiles at distance of 300mm-400mm from one another.

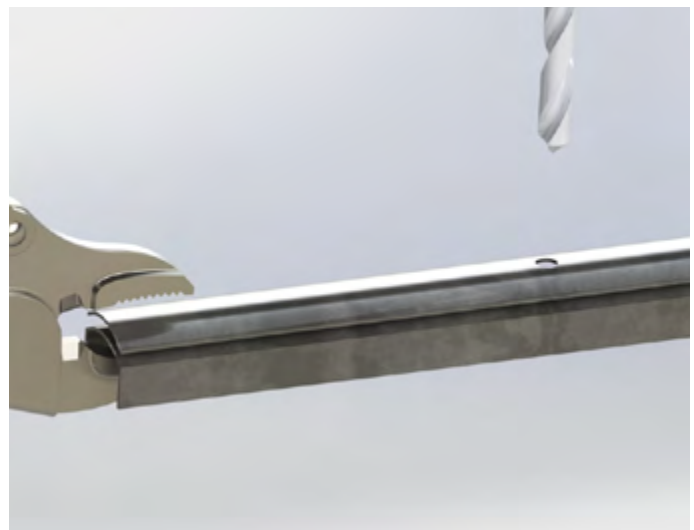

2

Install the first SUNTUF Plus sheet according to PALRAM's installation instructions

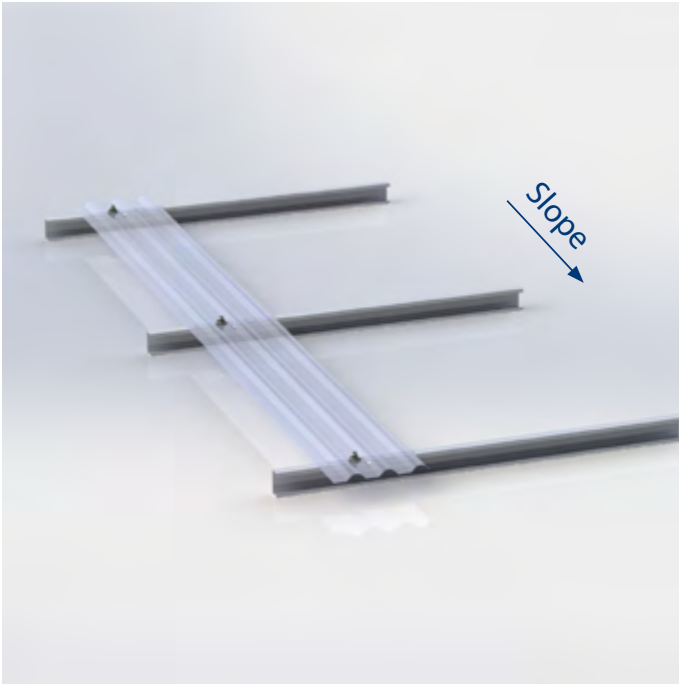

3

Place bottom part of side lap profile under the last corrugation crest

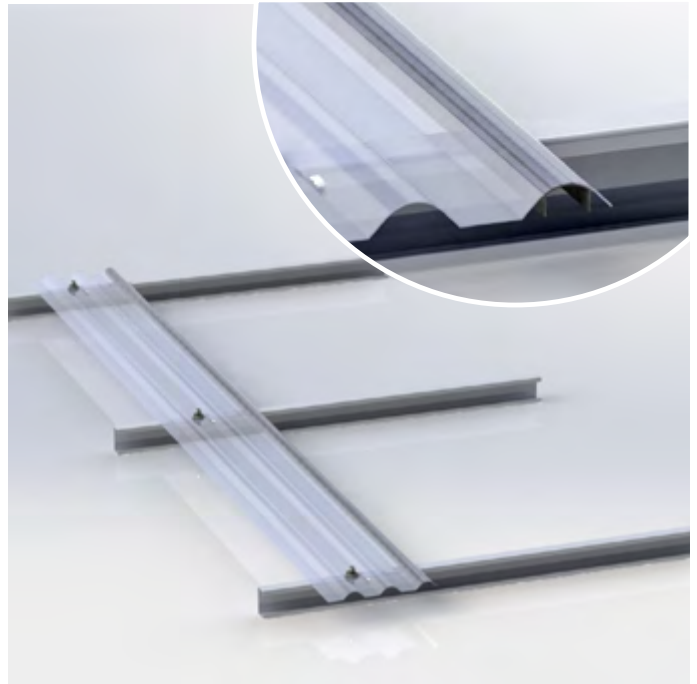

4

Install the next SUNTUF Plus sheet, first corrugation crest overlaps the previous sheet. Install the top part of the side lap profile above the SUNTUF Plus sheets. Locate the bores exactly above the bottom part bores.



5

Between purlins Install using 1/4*3/4 self tapping screw with 5/4 washer gasket. Above purlins install using 1/4*2" self drilling screw with 19mm washer/gasket.

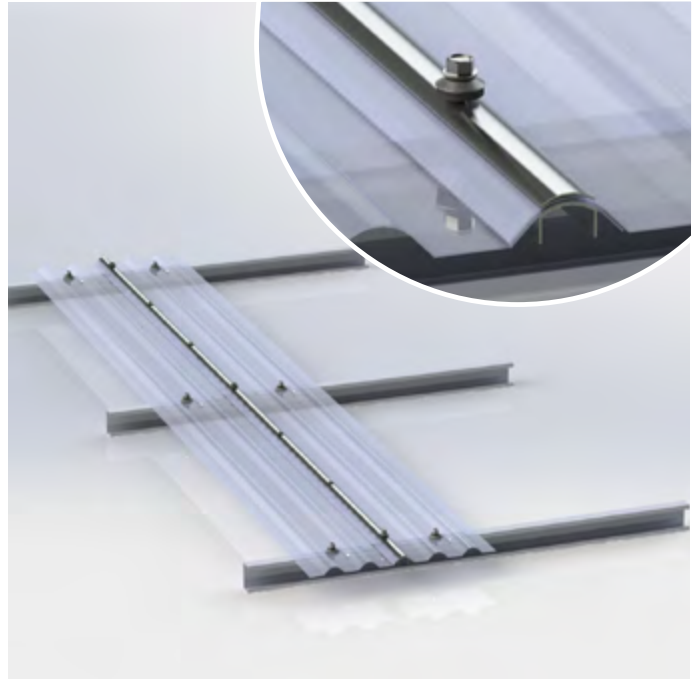

PALRAM H.Q.
Tel: +972 4 8459900
Fax: +972 4 8444012
palram@palram.com
www.palram.com

PALRAM EUROPE LTD.
Tel: +44 1302 380777
Fax: +44 1302 380778
sales.europe@palram.com
www.palram.com

PALRAM AMERICAS
Tel: 610 2859918
Fax: 610 2859928
palramamericas@palram.com
www.palramamericas.com



809008 - 06.2015

In as much as Palram Industries has no control over the use to which others may put the material, it does not guarantee that the same results as those described herein will be obtained. Each user of the material should make his own tests to determine the material's suitability for his own particular use. Statements concerning possible or suggested uses of the materials described herein are not to be construed as constituting a license under any Palram Industries patent covering such use or as recommendations for use of such materials in the infringement of any patent. Palram Industries or its distributors cannot be held responsible for any losses incurred through incorrect installation of the material. In accordance with our company policy of continual product development you are advised to check with your local Palram Industries supplier to ensure that you have obtained the most up to date information.

©2015 Palram Industries Ltd. | Side Lap Patent

