

# Polycarbonate Profiles

for SUNLITE® Multiwall Sheets

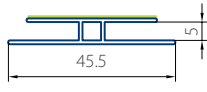
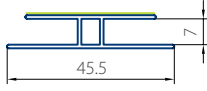
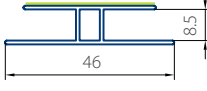
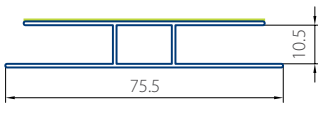
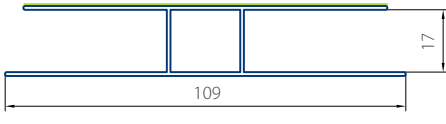
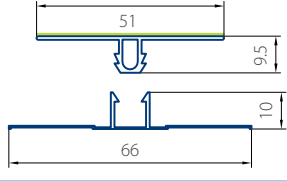
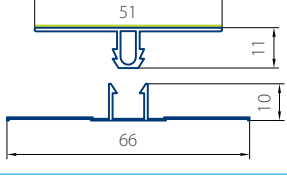
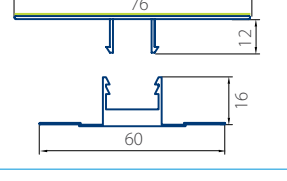
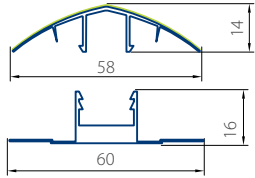

Type	Drawing	Length	Catalog Number
H Channel for 4mm Sheets (Profile HP 4)		12'	95565
		24'	95567
H Channel for 6mm Sheets (Profile HP 6)		12'	95568
		24'	95569
H Channel for 8mm Sheets (Profile HP 8)		12'	95570
		24'	95011
H Channel for 10mm Sheets (Profile HP 10)		12'	95571
		24'	95572
H Channel for 16mm Sheets (Profile HP 16)		12'	92714
		24'	93016
Press-Fit Sheet Connector for 6mm Sheets (Snap HCX Flat)		12'	Cap: 99189 Base: 99185
		24'	Cap: 99191 Base: 99186
Press-Fit Sheet Connector for 8mm & 10mm Sheets (Snap HCX Flat)		12'	Cap: 99187 Base: 99185
		24'	Cap: 99188 Base: 99186
Press-Fit Sheet Connector for 16mm Sheets (Snap HCX Flat)		12'	Cap: 99178 Base: 99180
		24'	Cap: 99179 Base: 99181
Universal Press-Fit Sheet Connector for 8mm & 10mm Sheets (Universal Snap HCX Capped)		12'	Cap: 99183 Base: 99180
		24'	Cap: 99184 Base: 99181

UV Protected Side

Type	Drawing	Length	Catalog Number
Ridge Cap Connector for 6mm Sheets (Ridge RP 6)		12'	95806
		24'	95807
Ridge Cap Connector for 8mm & 10mm Sheets (Ridge RP 8 & RP 10)		12'	93011
		24'	92920
Ridge Cap Connector for 16mm Sheets (Ridge RP 16)		12'	95808
		24'	95810
U Channel for 4mm Sheets (Profile UP 4)		12'	95575
		24'	95576
U Channel for 6mm Sheets (Profile UP 6)		12'	95554
		24'	95014
U Channel for 8mm Sheets (Profile UP 8)		12'	94570
		24'	94571
U Channel for 10mm Sheets (Profile UP 10)		12'	92715
		24'	92750
U Channel for 16mm Sheets (Profile UP 16)		12'	92730

### Sealing Tapes

Type	Drawing	Length	Suitable Sheets	Width	Catalog Number
Breather Tape		110' (33.52mm)	0.156" / 0.25" / 0.312" (4mm / 6mm / 8mm)	1" (25mm)	92696
			0.375" / 0.625" (10mm / 16mm)	1.5" (38mm)	92697
Solid Tape		160' (48.77mm)	0.156" / 0.25" / 0.312" (4mm / 6mm / 8mm)	1" (25mm)	92698
			0.375" / 0.625" (10mm / 16mm)	1.5" (38mm)	92699

## Typical Application of Polycarbonate Profiles

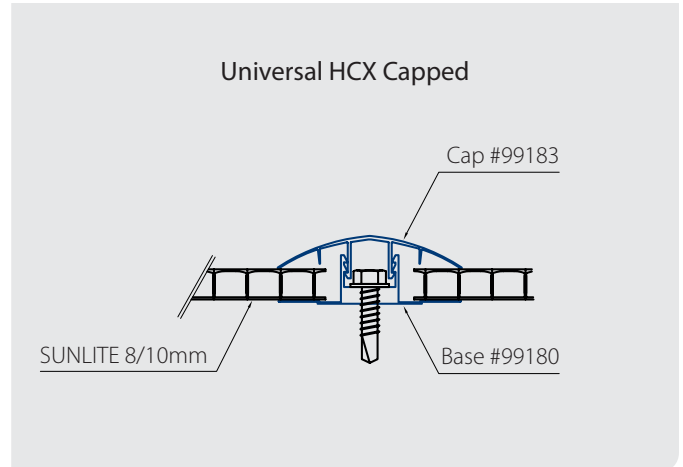
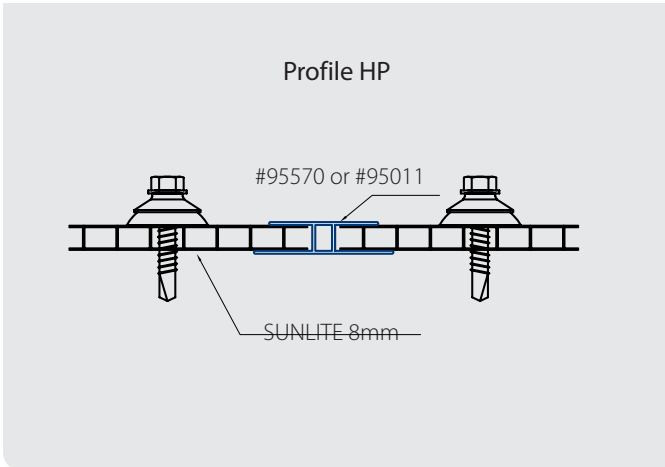
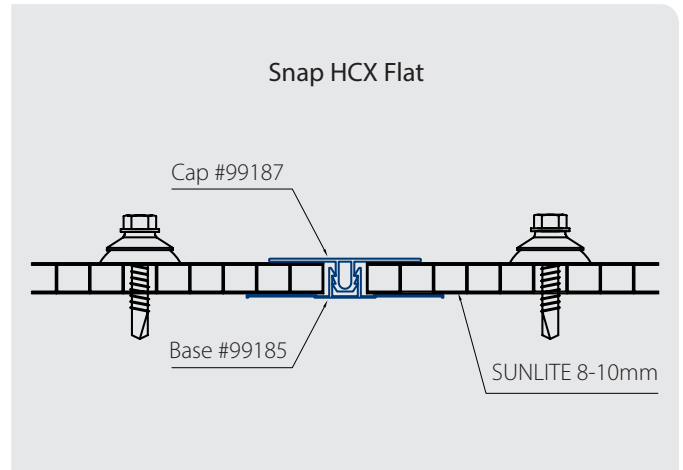
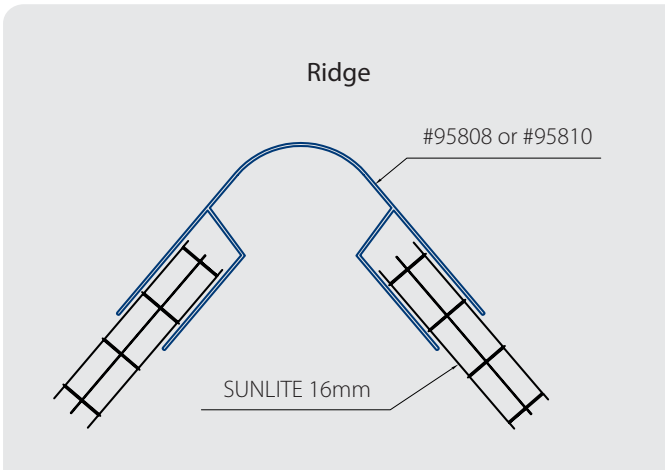

All marketing materials and any content therewith provided by Palram® are provided solely for the purpose of supporting and enhancing the marketing of Palram® products. These materials are protected by Palram's intellectual property rights and may not be used for any other purpose or in connection with the sale of products of any other manufacturer. These materials may not be transferred to or used by any third party without prior permission of Palram.



**PALRAM H.Q.**  
 Tel: +972 4 8459900  
 Fax: +972 4 8444012  
 palram@palram.com  
 www.palram.com

**PALRAM EUROPE LTD.**  
 Tel: +44 1302 380777  
 Fax: +44 1302 380788  
 sales.europe@palram.com

**PALRAM AMERICAS**  
 Tel: 610 2859918  
 Fax: 610 2859928  
 palramamericas@palram.com  
 www.palramamericas.com



61291 - 03.2019

In as much as Palram Industries has no control over the use to which others may put the material, it does not guarantee that the same results as those described herein will be obtained. Each user of the material should make his own tests to determine the material's suitability for his own particular use. Statements concerning possible or suggested uses of the materials described herein are not to be construed as constituting a license under any Palram Industries patent covering such use or as recommendations for use of such materials in the infringement of any patent. Palram Industries or its distributors cannot be held responsible for any losses incurred through incorrect installation of the material. In accordance with our company policy of continual product development you are advised to check with your local Palram Industries supplier to ensure that you have obtained the most up to date information.

